



## Accessories (Order Separately)

### Connecting Sockets

Applicable Relay model	Track/surface-mounting Socket		Back-mounting Socket	
	Screwless clamp terminal	Screw terminal	Terminals	Model
1 pole G2R-1-S(N)(D)(ND)(NI)(NDI)	• P2RF-05S (See note.) + (P2CM-S (option))	• P2RF-05-E • P2RF-05	PCB terminals	P2R-05P, P2R-057P
			Solder terminals	P2R-05A
2 poles G2R-2-S(N)(D)(ND)(NI)(NDI)	• P2RF-08S (See note.) + (P2CM-S (option))	• P2RF-08-E • P2RF-08	PCB terminals	P2R-08P, P2R-087P
			Solder terminals	P2R-08A

**Note:** Use of the P2CM Clip & Release Lever is recommended to ensure stable mounting.

### Accessories for Screwless Clamp Terminal Socket (Option)

Name	Model
Clip & Release Lever	P2CM-S
Nameplate	R99-11 Nameplate for MY
Socket Bridge	P2RM-SR (for AC), P2RM-SB (for DC)

### Mounting Tracks

Applicable Socket	Description	Model
Track-connecting Socket	Mounting track	50 cm (ℓ) x 7.3 mm (t): PFP-50N 1 m (ℓ) x 7.3 mm (t): PFP-100N 1 m (ℓ) x 16 mm (t): PFP-100N2
	End plate	PFP-M
	Spacer	PFP-S
Back-connecting Socket	Mounting plate	P2R-P*

\* Used to mount several P2R-05A and P2R-08A Connecting Sockets side by side.

## Specifications

### Coil Ratings

Rated voltage	Rated current*		Coil resistance*	Coil inductance (H) (ref. value)		Must operate voltage	Must release voltage	Max. voltage	Power consumption (approx.)	
	50 Hz	60 Hz		Armature OFF	Armature ON					
AC	24 V	43.5 mA	37.4 mA	253 Ω	0.81	1.55	80% max.	30% max.	110%	0.9 VA at 60 Hz
	110 V	9.5 mA	8.2 mA	5,566 Ω	13.33	26.83				
	120 V	8.6 mA	7.5 mA	7,286 Ω	16.13	32.46				
	230 V	4.4 mA	3.8 mA	27,172 Ω	72.68	143.90				
	240 V	3.7 mA	3.2 mA	30,360 Ω	90.58	182.34				

Rated voltage	Rated current*		Coil resistance*	Coil inductance (H) (ref. value)		Must operate voltage	Must release voltage	Max. voltage	Power consumption (approx.)
	50 Hz	60 Hz		Armature OFF	Armature ON				
DC	6 V	87.0 mA	69 Ω	0.25	0.48	70% max.	15% min.	110%	0.53 W
	12 V	43.2 mA	278 Ω	0.98	2.35				
	24 V	21.6 mA	1,113 Ω	3.60	8.25				
	48 V	11.4 mA	4,220 Ω	15.2	29.82				

\* The rated current and coil resistance are measured at a coil temperature of 23°C with tolerances of ±10%.

## Contact Ratings

Number of poles	1 pole		2 poles	
Load	Resistive load ( $\cos\phi = 1$ )	Inductive load ( $\cos\phi = 0.4$ ; L/R = 7 ms)	Resistive load ( $\cos\phi = 1$ )	Inductive load ( $\cos\phi = 0.4$ ; L/R = 7 ms)
Rated load	10 A at 250 VAC; 10 A at 30 VDC	7.5 A at 250 VAC; 5 A at 30 VDC	5 A at 250 VAC; 5 A at 30 VDC	2 A at 250 VAC; 3 A at 30 VDC
Rated carry current	10 A		5 A	
Max. switching voltage	440 VAC, 125 VDC		380 VAC, 125 VDC	
Max. switching current	10 A		5 A	
Max. switching power	2,500 VA, 300 W	1,875 VA, 150 W	1,250 VA, 150 W	500 VA, 90 W
Failure rate (reference value)	100 mA at 5 VDC		10 mA at 5 VDC	

Note: P level:  $\lambda_{60} = 0.1 \times 10^{-6}$ /operation

## Characteristics

Item	1 pole	2 poles
Contact resistance	100 mΩ max.	
Operate (set) time	15 ms max.	
Release (reset) time	AC: 10 ms max.; DC: 5 ms max. (w/built-in diode: 20 ms max.)	AC: 15 ms max.; DC: 10 ms max. (w/built-in diode: 20 ms max.)
Max. operating frequency	Mechanical: 18,000 operations/hr Electrical: 1,800 operations/hr (under rated load)	
Insulation resistance	1,000 MΩ min. (at 500 VDC)	
Dielectric strength	5,000 VAC, 50/60 Hz for 1 min between coil and contacts*; 1,000 VAC, 50/60 Hz for 1 min between contacts of same polarity	5,000 VAC, 50/60 Hz for 1 min between coil and contacts*; 3,000 VAC, 50/60 Hz for 1 min between contacts of different polarity 1,000 VAC, 50/60 Hz for 1 min between contacts of same polarity
Vibration resistance	Destruction: 10 to 55 to 10 Hz, 0.75 mm single amplitude (1.5 mm double amplitude) Malfunction: 10 to 55 to 10 Hz, 0.75 mm single amplitude (1.5 mm double amplitude)	
Shock resistance	Destruction: 1,000 m/s <sup>2</sup> Malfunction: 200 m/s <sup>2</sup> when energized; 100 m/s <sup>2</sup> when not energized	
Endurance	Mechanical: AC coil: 10,000,000 operations min.; DC coil: 20,000,000 operations min. (at 18,000 operations/hr) Electrical: 100,000 operations min. (at 1,800 operations/hr under rated load) (DC coil type)	
Ambient temperature	Operating: -40°C to 70°C (with no icing or condensation)	
Ambient humidity	Operating: 5% to 85%	
Weight	Approx. 21 g	

Note: Values in the above table are the initial values.

\*4,000 VAC, 50/60 Hz for 1 minute when the P2R-05A or P2R-08A Socket is mounted.

## Approved Standards

### UL 508 (File No. E41643)

Model	Coil ratings	Contact form	Contact ratings	Operations
G2R-1-S	5 to 110 VDC 6 to 240 VAC	SPDT	10 A, 30 VDC (resistive) 10 A, 250 VAC (general use) TV-3 (NO contact only)	6 x 10 <sup>3</sup>
G2R-2-S			5 A, 30 VDC (resistive) 5 A, 250 VAC (general use) TV-3 (NO contact only)	6 x 10 <sup>3</sup>

### CSA 22.2 No.0, No.14 (File No. LR31928)

Model	Coil ratings	Contact form	Contact ratings	Operations
G2R-1-S	5 to 110 VDC 6 to 240 VAC	SPDT	10 A, 30 VDC (resistive) 10 A, 250 VAC (general use) TV-3 (NO contact only)	6 x 10 <sup>3</sup>
G2R-2-S			5 A, 30 VDC (resistive) 5 A, 250 VAC (general use) TV-3 (NO contact only)	6 x 10 <sup>3</sup>

### IEC/VDE (EN61810)

Contact form	Coil ratings	Contact ratings	Operations
1 pole	6, 12, 24, 48 VDC 24, 110, 120, 230, 240 VAC	5 A, 440 VAC ( $\cos\phi = 1.0$ ) 10 A, 250 VAC ( $\cos\phi = 1.0$ ) 10 A, 30 VDC (0 ms)	100 x 10 <sup>3</sup>
2 poles	6, 12, 24, 48 VDC 24, 110, 120, 230, 240 VAC	5 A, 250 VAC ( $\cos\phi = 1.0$ ) 5 A, 30 VDC (0 ms)	100 x 10 <sup>3</sup>

### LR

Number of poles	Coil ratings	Contact ratings	Operations
1 pole	5 to 110 VDC 6 to 240 VDC	10 A, 250 VAC (general use) 7.5 A, 250 VAC (PF0.4) 10 A, 30 VDC (resistive) 5A, 30VDC (L/R=7ms)	100 x 10 <sup>3</sup>
2 poles	5 to 110 VDC 6 to 240 VDC	5 A, 250 VAC (general use) 2 A, 250 VAC (PF0.4) 5 A, 30 VDC (resistive) 3A, 30VDC (L/R=7ms)	100 x 10 <sup>3</sup>

# Engineering Data

## Maximum Switching Power

### Plug-in Relays

G2R-1-S

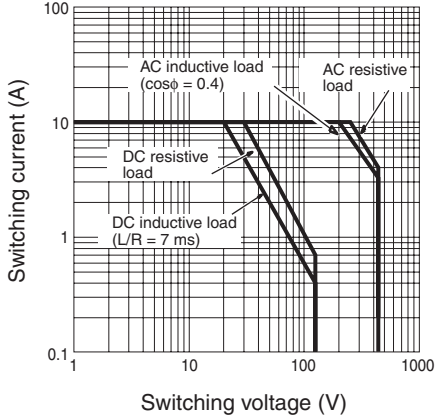

G2R-2-S

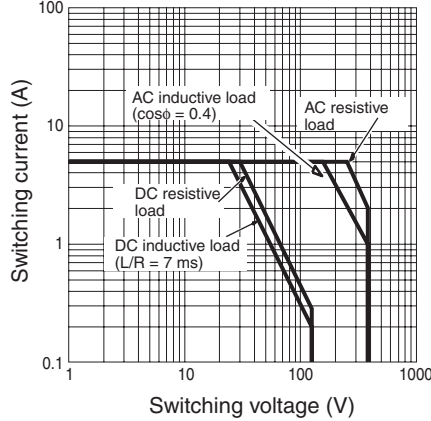

## Endurance

### Plug-in Relays

G2R-1-S

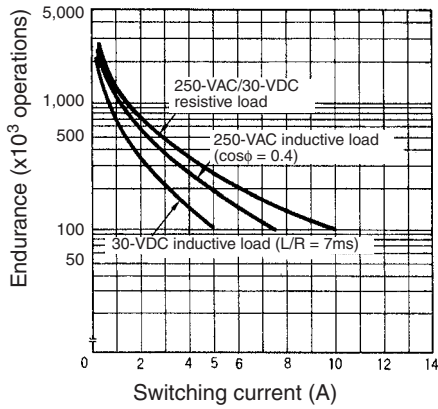

G2R-2-S

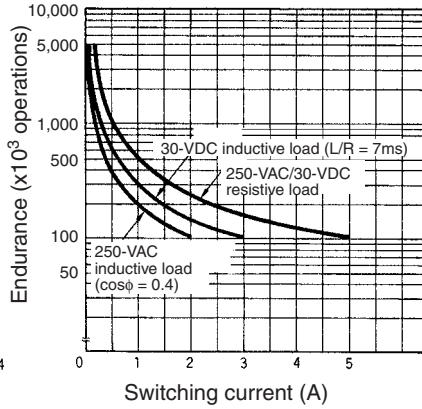

## Ambient Temperature vs Maximum Coil Voltage

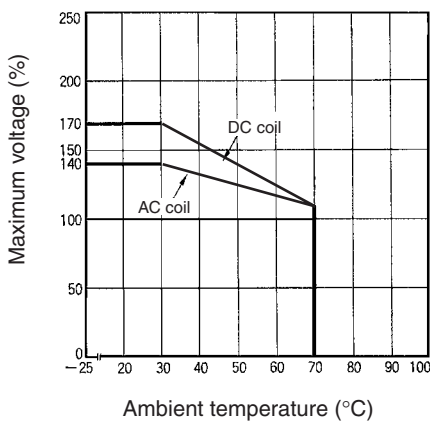

**Note:** The maximum voltage refers to the maximum value in a varying range of operating power voltage, not a continuous voltage.

# Dimensions

Note: All units are in millimeters unless otherwise indicated.

## Relays with Plug-in Terminals

### SPDT Relays

G2R-1-S, G2R-1-SN, G2R-1-SNI (S)  
 G2R-1-SD, G2R-1-SND, G2R-1-SNDI (S)

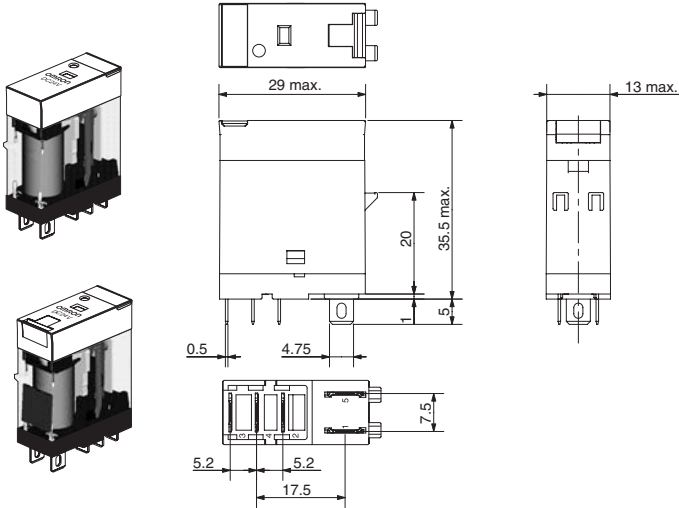

### Terminal Arrangement/Internal Connections (Bottom View)

G2R-1-S

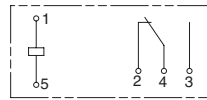

G2R-1-SD (DC)

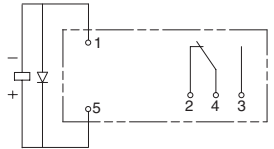

G2R-1-SN, G2R-1-SNI (AC)

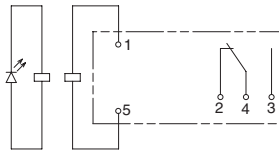

G2R-1-SN, G2R-1-SNI (DC)

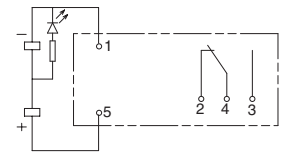

G2R-1-SND, G2R-1-SNDI (DC)

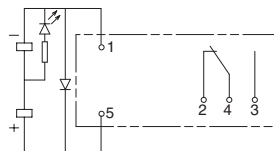

### DPDT Relays

G2R-2-S, G2R-2-SN, G2R-2-SNI (S)  
 G2R-2-SD, G2R-2-SND, G2R-2-SNDI (S)

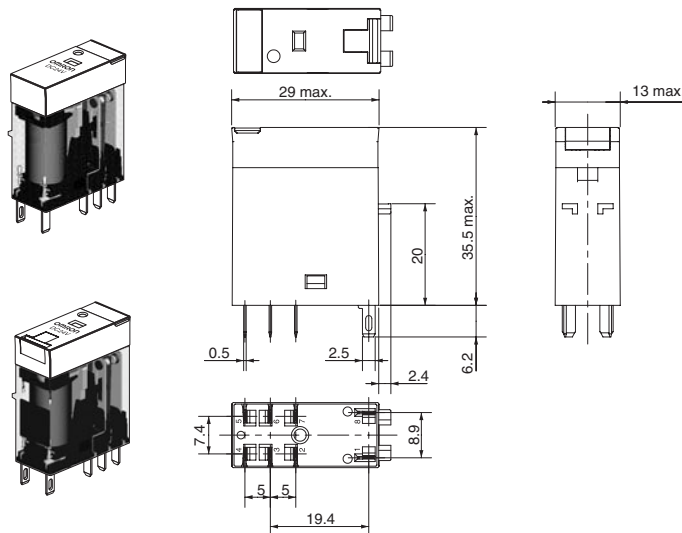

### Terminal Arrangement/Internal Connections (Bottom View)

G2R-2-S

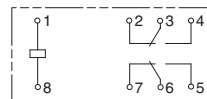

G2R-2-SD (DC)

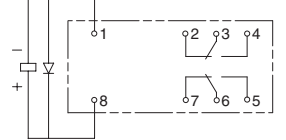

G2R-2-SN, G2R-2-SNI (AC)

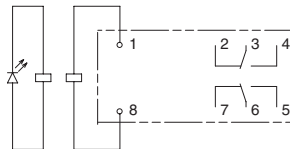

G2R-2-SN, G2R-2-SNI (DC)

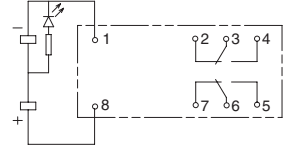

G2R-2-SND, G2R-2-SNDI (DC)

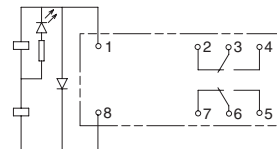

### Track/Surface Mounting Sockets

#### P2RF-05-S

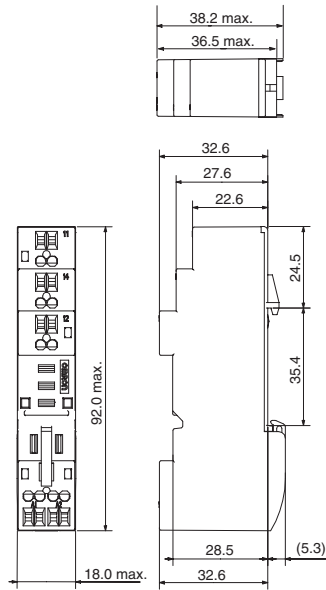
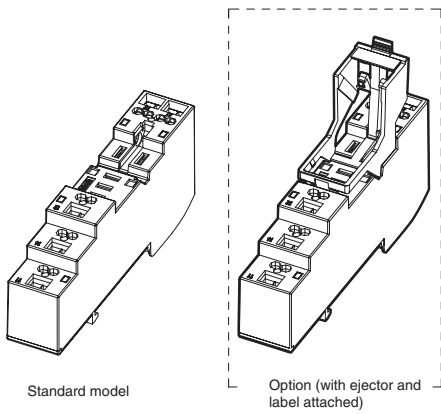

Terminal Arrangement (Top View)

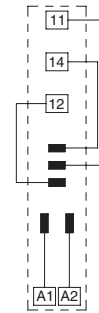

#### P2RF-08-S

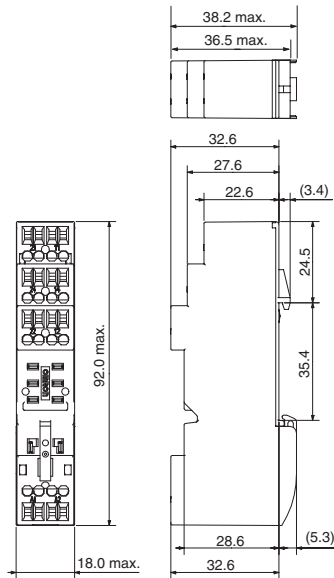
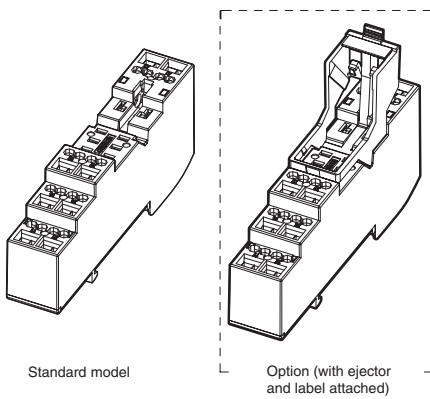

Terminal Arrangement (Top View)

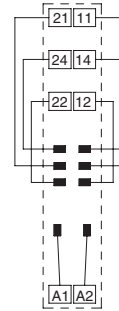

### Accessories for P2RF-□-S

#### Socket Bridge

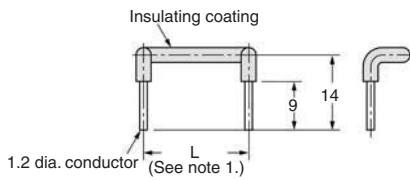

#### Clip and Release Lever

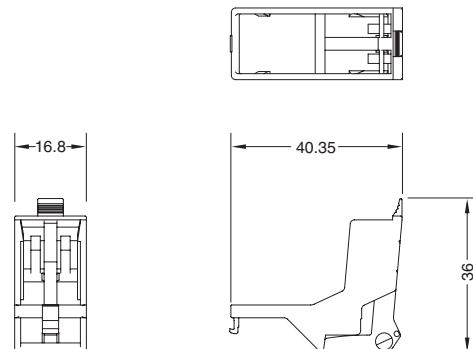

**P2RF-05-E**

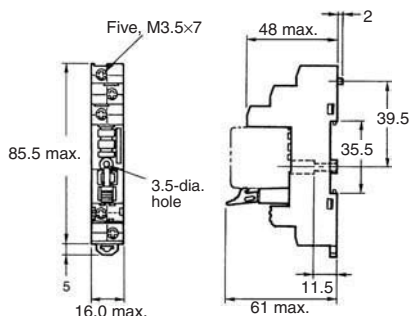
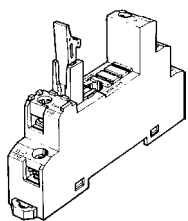

**Terminal Arrangement (Top View)**

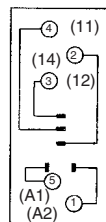

**Mounting Holes (for Surface Mounting)**

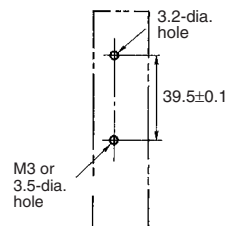

**Note:** Pin numbers in parentheses apply to DIN standard.

**P2RF-08-E**

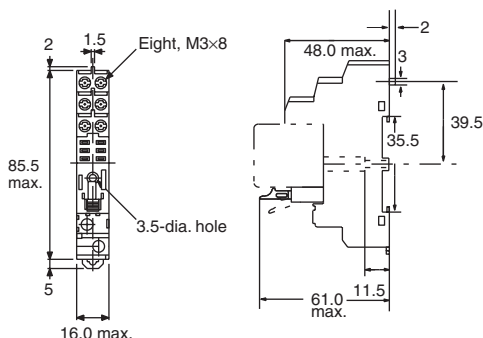
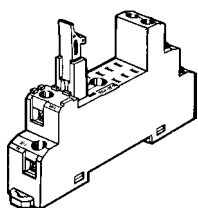

**Terminal Arrangement (Top View)**

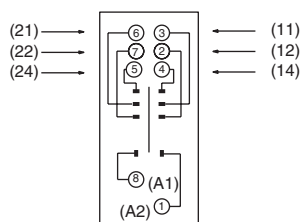

**Mounting Holes (for Surface Mounting)**

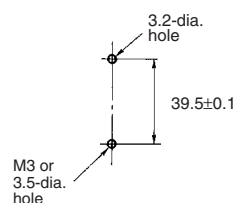

**P2RF-05**

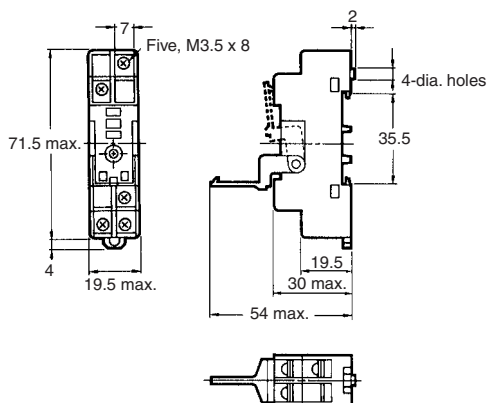
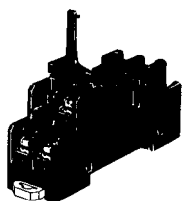

**Terminal Arrangement (Top View)**

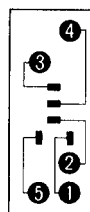

**Mounting Holes (for Surface Mounting)**

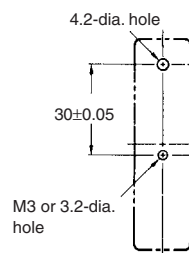

**P2RF-08**

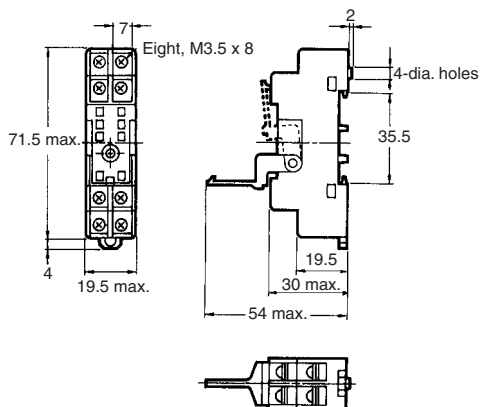
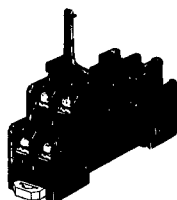

**Terminal Arrangement (Top View)**

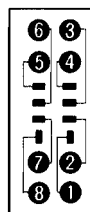

**Mounting Holes (for Surface Mounting)**

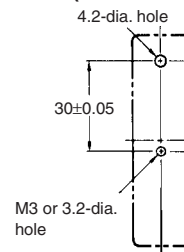

### Mounting Height of Relay with Track/Surface Mounting Sockets

P2RF-□

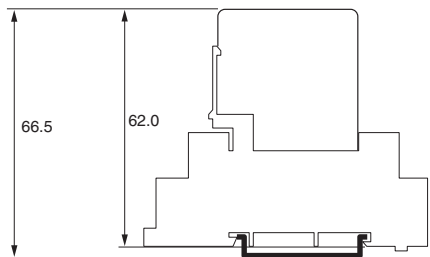

P2RF-□-E

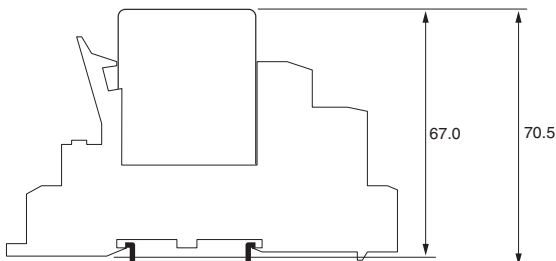

P2RF-□-S

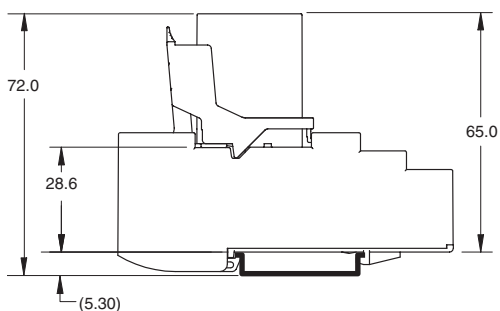

### Back-connecting Sockets

P2R-05P (1-pole)

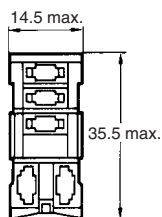
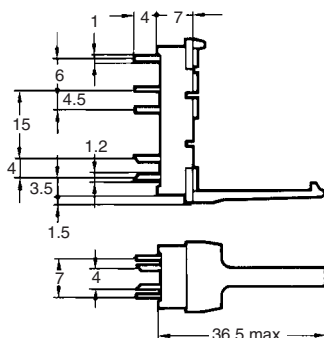
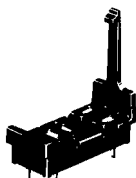

Terminal Arrangement (Bottom View)

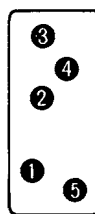

Mounting Holes

Tolerance: ±0.1

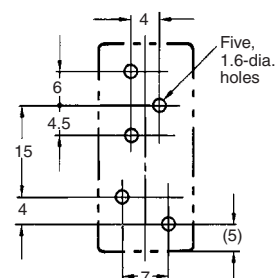

P2R-08P (2-pole)

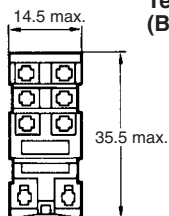
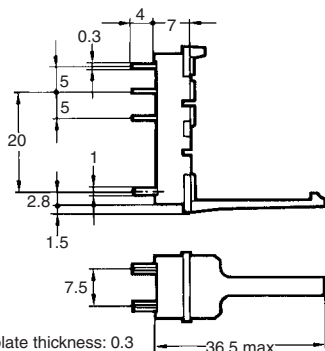
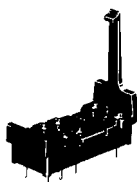

Terminal Arrangement (Bottom View)

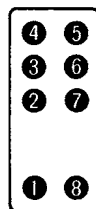

Mounting Holes

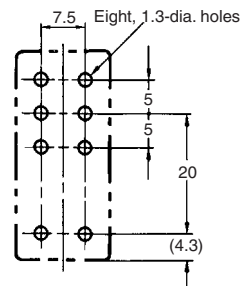



**P2R-05A (1-pole)**

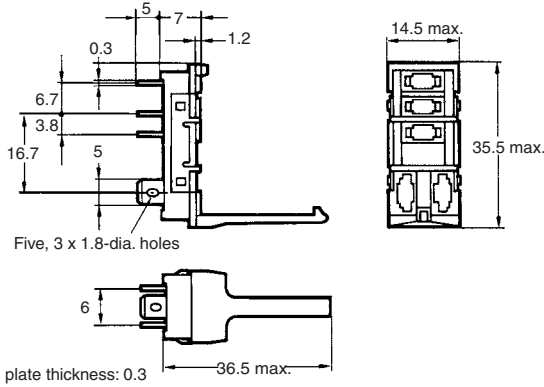
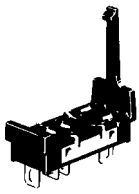

**Terminal Arrangement (Bottom View)**

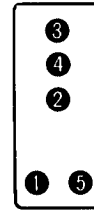

**Panel Cutout**

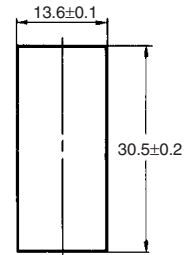

Recommended thickness of the panel is 1.6 to 2.0 mm

**P2R-08A (2-pole)**

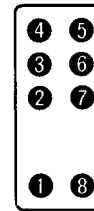
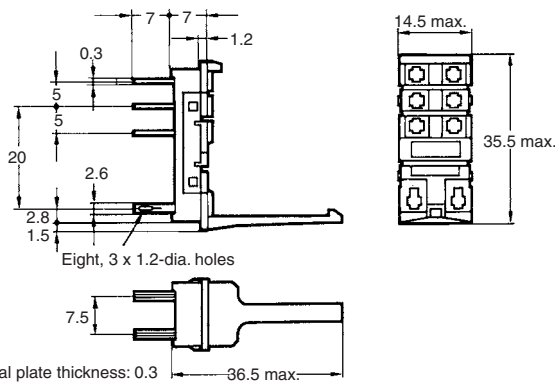
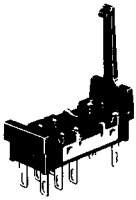

**P2R-057P**

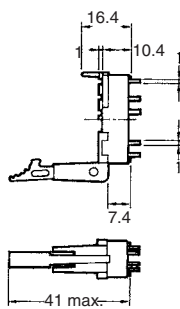
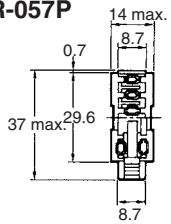

**Terminal Arrangement (Bottom View)**

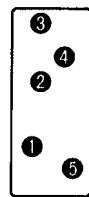

**Mounting Holes**

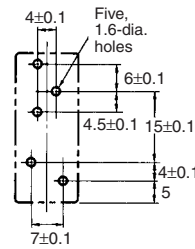

**P2R-087P**

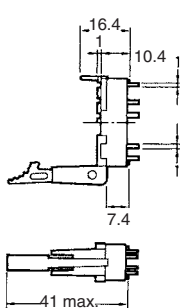
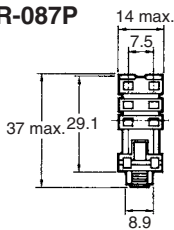

**Terminal Arrangement (Bottom View)**

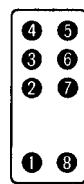

**Mounting Holes**

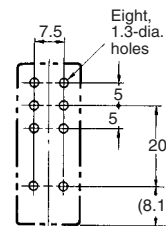

**Mounting Height of Relay with Back-connecting Sockets**

**G2R-□P**

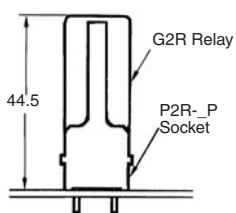

**G2R-□A**

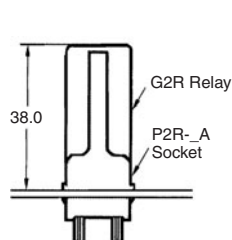

**G2R-□7P**

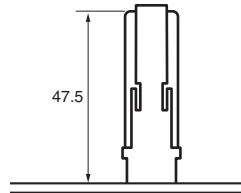

## Mounting Tracks

### PFP-100N, PFP-50N

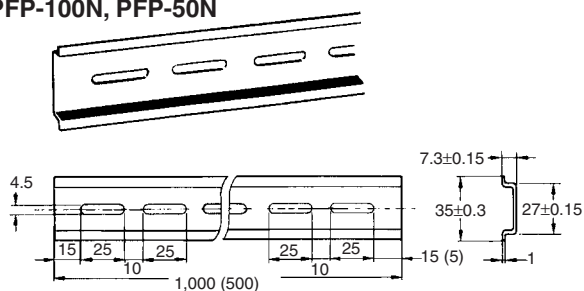

It is recommended to use a panel 1.6 to 2.0 mm thick.

### PFP-100N2

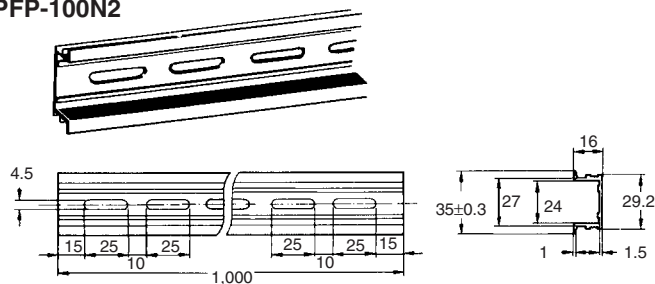

## End Plate

### PFP-M

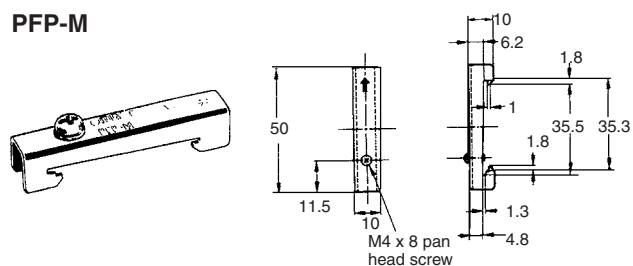

## Spacer

### PFP-S

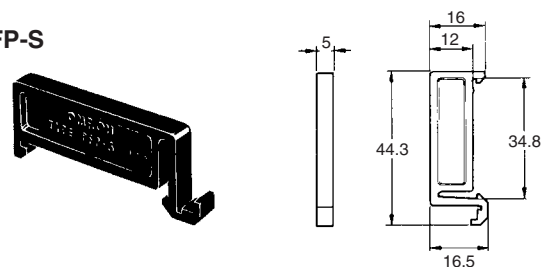

## Precautions

### ⚠ Cation

- Do not use the test button for any purpose other than testing. Be sure not to touch the test button accidentally as this will turn the contacts ON. Before using the test button, confirm that circuits, the load, and any other connected item will operate safely.
- Check that the test button is released before turning ON relay circuits.
- If the test button is pulled out too forcefully, it may bypass the momentary testing position and go straight into the locked position.
- Use an insulated tool when you operate the test button.

### Precautions for P2RF-□-S Connection

- Do not move the screwdriver up, down, or from side to side while it is inserted in the hole. Doing so may cause damage to internal components (e.g., deformation of the clamp spring or cracks in the housing) or cause deterioration of insulation.
- Do not insert the screwdriver at an angle. Doing so may break the side of the socket and result in a short-circuit.

## Terms and Conditions Agreement

### Read and understand this catalog.

Please read and understand this catalog before purchasing the products. Please consult your OMRON representative if you have any questions or comments.

### Warranties.

(a) Exclusive Warranty. Omron's exclusive warranty is that the Products will be free from defects in materials and workmanship for a period of twelve months from the date of sale by Omron (or such other period expressed in writing by Omron). Omron disclaims all other warranties, express or implied.

(b) Limitations. OMRON MAKES NO WARRANTY OR REPRESENTATION, EXPRESS OR IMPLIED, ABOUT NON-INFRINGEMENT, MERCHANTABILITY OR FITNESS FOR A PARTICULAR PURPOSE OF THE PRODUCTS. BUYER ACKNOWLEDGES THAT IT ALONE HAS DETERMINED THAT THE PRODUCTS WILL SUITABLY MEET THE REQUIREMENTS OF THEIR INTENDED USE.

Omron further disclaims all warranties and responsibility of any type for claims or expenses based on infringement by the Products or otherwise of any intellectual property right. (c) Buyer Remedy. Omron's sole obligation hereunder shall be, at Omron's election, to (i) replace (in the form originally shipped with Buyer responsible for labor charges for removal or replacement thereof) the non-complying Product, (ii) repair the non-complying Product, or (iii) repay or credit Buyer an amount equal to the purchase price of the non-complying Product; provided that in no event shall Omron be responsible for warranty, repair, indemnity or any other claims or expenses regarding the Products unless Omron's analysis confirms that the Products were properly handled, stored, installed and maintained and not subject to contamination, abuse, misuse or inappropriate modification. Return of any Products by Buyer must be approved in writing by Omron before shipment. Omron Companies shall not be liable for the suitability or unsuitability or the results from the use of Products in combination with any electrical or electronic components, circuits, system assemblies or any other materials or substances or environments. Any advice, recommendations or information given orally or in writing, are not to be construed as an amendment or addition to the above warranty.

See <http://www.omron.com/global/> or contact your Omron representative for published information.

### Limitation on Liability; Etc.

OMRON COMPANIES SHALL NOT BE LIABLE FOR SPECIAL, INDIRECT, INCIDENTAL, OR CONSEQUENTIAL DAMAGES, LOSS OF PROFITS OR PRODUCTION OR COMMERCIAL LOSS IN ANY WAY CONNECTED WITH THE PRODUCTS, WHETHER SUCH CLAIM IS BASED IN CONTRACT, WARRANTY, NEGLIGENCE OR STRICT LIABILITY.

Further, in no event shall liability of Omron Companies exceed the individual price of the Product on which liability is asserted.

### Suitability of Use.

Omron Companies shall not be responsible for conformity with any standards, codes or regulations which apply to the combination of the Product in the Buyer's application or use of the Product. At Buyer's request, Omron will provide applicable third party certification documents identifying ratings and limitations of use which apply to the Product. This information by itself is not sufficient for a complete determination of the suitability of the Product in combination with the end product, machine, system, or other application or use. Buyer shall be solely responsible for determining appropriateness of the particular Product with respect to Buyer's application, product or system. Buyer shall take application responsibility in all cases.

NEVER USE THE PRODUCT FOR AN APPLICATION INVOLVING SERIOUS RISK TO LIFE OR PROPERTY OR IN LARGE QUANTITIES WITHOUT ENSURING THAT THE SYSTEM AS A WHOLE HAS BEEN DESIGNED TO ADDRESS THE RISKS, AND THAT THE OMRON PRODUCT(S) IS PROPERLY RATED AND INSTALLED FOR THE INTENDED USE WITHIN THE OVERALL EQUIPMENT OR SYSTEM.

### Programmable Products.

Omron Companies shall not be responsible for the user's programming of a programmable Product, or any consequence thereof.

### Performance Data.

Data presented in Omron Company websites, catalogs and other materials is provided as a guide for the user in determining suitability and does not constitute a warranty. It may represent the result of Omron's test conditions, and the user must correlate it to actual application requirements. Actual performance is subject to the Omron's Warranty and Limitations of Liability.

### Change in Specifications.

Product specifications and accessories may be changed at any time based on improvements and other reasons. It is our practice to change part numbers when published ratings or features are changed, or when significant construction changes are made. However, some specifications of the Product may be changed without any notice. When in doubt, special part numbers may be assigned to fix or establish key specifications for your application. Please consult with your Omron's representative at any time to confirm actual specifications of purchased Product.

### Errors and Omissions.

Information presented by Omron Companies has been checked and is believed to be accurate; however, no responsibility is assumed for clerical, typographical or proofreading errors or omissions.

2016.1

In the interest of product improvement, specifications are subject to change without notice.

**OMRON Corporation**  
Industrial Automation Company

<http://www.ia.omron.com/>

(c)Copyright OMRON Corporation 2016 All Right Reserved.